



شركة
اشوار
ashwar
LTD. المحدودة



Fingerprint



Password

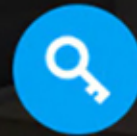

Mechanical key

FINGERPRINT/PASSWORD LOCK



PHONE : 0550666366-0567377887

website: www.ashwar.com

Email : jazan@ashwar.com

Add: ASHWAR LTD, Jazan Industrial City, Jazan-KSA

HOT! Model: S807L	DETAILS
 <p>Red bronze /Black:</p>	<p>Materail: Aluminum alloy+Acrylic Unlock: Tuya wifi app/TT lock app&Password & Fingerprint & card & key &USB port Door thickness:38-55mm Size:250*64*22mm Weight:2.5kg/pcs</p> <p>using for wooden door , metal door, composite door</p> <p>4 AA Alkaline Battery</p>

HOT! Model: S807	DETAILS
 <p>Red bronze /Black:</p>	<p>Materail: Aluminum alloy+Acrylic Unlock: Tuya wifi app/TT lock app&Password & Fingerprint & card & key &USB port Door thickness:38-55mm Size:240*60*22mm Weight:2.5kg/pcs</p> <p>using for wooden door , metal door, composite door</p> <p>4 AAA Alkaline Battery</p>

HOT!	Model: S809	DETAILS
		Materail: Aluminum alloy+Acrylic Unlock: Tuya wifi app/TT lock app/DADA LOCK&Password & Fingerprint & card & key &USB port Door thickness:38-55mm Size:257*65*155mm Weight: 2.5kg/pcs using for wooden door , metal door, composite door
Black:		4 AA Alkaline Battery

HOT!	Model: S807X	DETAILS
		Materail: Aluminum alloy+Acrylic Unlock: Tuya wifi app/TT lock app &Password & Fingerprint & card & key &USB port Door thickness:38-55mm Size:305*65*25mm Weight: 3.5kg/pcs using for wooden door, metal door, composite door
Red bronze /Black:		4 AA Alkaline Battery

HOT!	Model: S806	DETAILS
		Materail: Aluminum alloy + Acrylic Unlock: Tuya wifi app/TT lock app &Password & Fingerrpint & card & key &USB port Door thickness: 38-55mm Size: 250*60*20mm Weight: 2.5kg/pcs using for wooden door, metal door, composite door
Red bronze /Black:		4 AAA Alkaline Battery

HOT! Model: S801L	DETAILS
	<p> Material: Aluminum alloy+Acrylic Unlock: Tuya wifi app/TT lock app&Password & Fingerprint & card & key &USB port Door thickness:38-55mm Size: 255*65*21mm using for wooden door, metal door, composite door Weight: 2.5kg/pcs 4 AA Alkaline Battery </p>
Red bronze /Black:	

HOT! Model: S810	DETAILS
	<p> Material: Aluminum alloy+Acrylic Unlock: Tuya BLE &Password & Fingerprint & card & key &USB port Door thickness:38-55mm using for wooden door, metal door, composite door Weight: 2.5kg/pcs 4 AA Alkaline Battery </p>
Black:	

HOT! Model: S811	DETAILS
	<p> Material: Aluminum alloy+Acrylic Unlock: Tuya WIFI &Password & Fingerprint & card & key &USB port Door thickness:38-55mm using for wooden door, metal door, composite door Weight: 2.5kg/pcs 4 AAA Alkaline Battery </p>
Black:	

<p>HOT! Model: S818</p>	<p style="text-align: center;">DETAILS</p>
	<p> Material: Aluminum alloy+Acrylic Unlock: Tuya wifi app/TT lock app&Password & Fingerprint &Wechat& card & key &USB port Door thickness:38-100mm Size: 370*75*24mm Weight: 4kg/pcs using for wooden door, metal door, composite door 4 AA Alkaline Battery </p>
<p>Red bronze /Black</p>	

<p>HOT! Model: S819</p>	<p style="text-align: center;">DETAILS</p>
	<p> Material: Aluminum alloy+Acrylic Unlock: Tuya wifi app/TT lock app&Password & Fingerprint &Wechat& card & key &USB port Door thickness:38-100mm Weight: 4kg/pcs using for wooden door, metal door, composite door 4 AA Alkaline Battery </p>
<p>Black</p>	

<p>HOT! Model: S928MAX</p>	<p style="text-align: center;">DETAILS</p>
	<p> Material: Aluminum alloy S928MAX Unlock: Wifi app(USmart GO) & password & fingerprint & card & key Door thickness: 40-110mm using for wooden door metal door, composite door Weight: 6kg/pcs 7.4V 4200mAh Lithium-ion rechargeable battery </p>
<p>Grey</p>	

HOT! Model: S921MAX	DETAILS
	Materail: Aluminum alloy S928MAX Unlock: Wifi app(USmart GO) & password & fingerprint & card & key Door thickness: 40-110mm using for wooden door metal door, composite door Weight: 6kg/pcs 7.4V 4200mAh Lithium-ion rechargeable battery
Grey/champagne gold	

HOT! Model: S931MAX 3D Face ID+ camera S931 camera	DETAILS
	Materail: Aluminum alloy S931MAX Unlock: 3DFace&USmart GO & password & fingerprint & card & key& video calling S931 Unlock: USmart GO & password & fingerprint & card & key& video calling
S931MAX Black S931 Black	Door thickness: 40-110mm Weight: 6kg/pcs 7.4V 4200mAh Lithium-ion rechargeable battery

HOT! Model: S935MAX camera	DETAILS
	Materail: Aluminum alloy Unlock: Xhome & password & fingerprint & card & key& video calling Door thickness: 40-110mm using for wooden door metal door, composite door Weight: 6kg/pcs 7.4V 4200mAh Lithium-ion rechargeable battery
Dark Grey	

HOT! Model: S936MAX camera	DETAILS
	<p>Materail: Aluminum alloy Unlock: USmart go & password & fingerprprint & card & key Door thickness: 40-110mm using for wooden door metal door, composite door Weight: 6kg/pcs 7.4V 4200mAh Lithium-ion rechargeable battery</p>
Dark grey/Black	

HOT! Model: S928	DETAILS
	<p>Materail: Aluminum alloy Unlock: Tuya app & password & fingerprprint & card & key Door thickness: 40-110mm using for wooden door metal door, composite door Weight: 6kg/pcs 7.4V 3200mAh Lithium-ion rechargeable battery</p>
S928: Grey/black/rose gold	

HOT! Model: S921	DETAILS
	<p>Materail: Aluminum alloy+Acrylic Unlock: Tuya app/TTlock app & password & fingerprint & card & key Door thickness: 38-55mm using for wooden door ,metal door Weight: 2.5kg/pcs 4 AA Alkaline Battery</p>
Tuya TTlock	

HOT!	Model: S823	DETAILS
		Material: 304 stainless steel, Tempered glass Unlock: TTlock app & Password & fingerprint & card & key & USB port Door thickness: 30-60mm using for wooden door Panel size: 310*40mm Weight: 3.5kg/pcs Power: 4 AA Alkaline Battery
Silver	Black	

HOT!	Model: S824	DETAILS
		Material: 304 stainless steel, Tempered glass Unlock: Tuya app & Password & fingerprint & card & key & USB port Door thickness: 30-60mm using for wooden door Panel size: 310*40mm Weight: 3.5kg/pcs Power: 4 AAA Alkaline Battery
Silver /Black		

HOT!	Model: S616	DETAILS
		Material: 304 stainless steel, Tempered glass Unlock: Tuya app & Password & fingerprint & card & key & USB port Door thickness: 30-60mm using for metal door, wooden door Panel size: 291*36.6mm Weight: 4kg/pcs Power: 4 AAA Alkaline Battery Waterproof : IP65
Silver/champagne gold		

<p>HOT! Model: S617</p>	<p>DETAILS</p>
 <p>Waterproof and corrosion resistant, specially designed for outdoor Zinc Alloy materials IP65 waterproof</p>	<p>Materail: Zinc alloy, Tempered glass Unlock: TTlock app & Password & fingerprint & card & key & USB port Door thickness: 30-60mm using for metal door, wooden door Weight: 4kg/pcs Power: 4 AAA Alkaline Battery Waterproof :IP65</p>
<p>Black</p>	

<p>HOT! Model: S618 Access control</p>	<p>DETAILS</p>
	<p>Access control Materail: Aluminum alloy Unlock: TTlock app & Password & card Panel size: 315*35mm Weight: 1kg/pcs Waterproof :IP66</p>
<p>Black</p>	

<p>HOT! Model: S619</p>	<p>DETAILS</p>
	<p>Materail: Aluminum alloy Unlock: Tuya app & Password & fingerprint & card & key & USB port Door thickness: 30-60mm using for metal door, wooden door Panel size: 315*35mm Weight: 5.5kg/pcs Power: 4 AAA Alkaline Battery Waterproof :IP68 Double side fingerprint extra 20USD</p>
<p>Sliver</p>	

TTlock Bluetooth Gateway	Details
	<p>TTlock Bluetooth Weight: 0.5kg/pcs Gateway</p>

Tuya Bluetooth Gateway	Details
	<p>Tuya Bluetooth Weight: 0.5kg/pcs Gateway</p>

Model: S701 100% Waterproof	DETAILS
	<p> Materail: SUS304 stainless steel Unlock: Mechanical Password & Mechanical key Door thickness: 38-100mm using for wooden door metal door, composite door Panel size: 190*43mm Working temperature: -70~100℃ Weight: 3 kg/pcs Color: Silver/Black/red bronze </p>
<p> Silver/Black/red bronze: (one side password) (double side password) </p>	

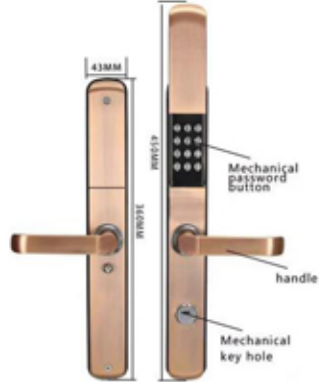
Model: S702 100% Waterproof	DETAILS
	<p> Material: Aluminum alloy Unlock: Mechanical Password & Mechanical key Door thickness: 38-100mm using for indoor or outdoor Panel size: 360*43mm Working temperature: -70~100℃ Weight: 5.5 kg/pcs Color: Black/red bronze </p>
Black/red bronze: (one side password)	

HOT! Model: S919-1MAX (camera) S919-2MAX (3D Face ID + camera)	DETAILS
	<p> Material: Aluminum alloy S919-1MAX Unlock: Wifi app(USmart GO/Tuya app) & password & fingerprint & card & key S919-2MAX Unlock: 3D Face ID & Wifi app (USmart GO/Tuya app) & password & fingerprint & card & key Door thickness: 40-110mm using for wooden door, metal door, composite door Weight: 6kg/pcs 7.4V 4200mAh Lithium-ion rechargeable battery </p>
<p> S919-1max Grey: (USmart GO App) (Tuya App) S919-2max Gun black: (Tuya app) (Usmart go app) </p>	

HOT! Model: S922 (Automatic) S922MAX (camera)	DETAILS
	<p>Material: Aluminum alloy</p> <p>S922 Unlock: Tuya app/Tuya BLE & password & fingerprint & card & key</p> <p>S922MAX Unlock: Wifi app (USmart GO/Tuya app) & password & fingerprint & card & key</p> <p>Door thickness: 40-110mm using for wooden door, metal door, composite door</p> <p>Weight: 6kg/pcs</p> <p>7.4V 4200mAh Lithium-ion rechargeable battery</p>
<p>S922 Black: (Tuya) (Tuya BLE)</p> <p>S922max Black: (Usmart go) (Tuya)</p>	

Model: S912(Aumatic) S912max(camera)	DETAILS
	<p>Material: Aluminum alloy + Acrylic</p> <p>Unlock: Tuya & password & fingerprint & card & key (S912max camera USmart Go APP)</p> <p>Door thickness: 40-110mm</p> <p>Size: 394*78mm using for wooden door, metal door, composite door</p> <p>Weight: 6kg/pcs</p> <p>7.4V 3200mAh Lithium-ion rechargeable battery</p>
<p>Black/Red bronze/Gold: S912 S912MAX</p>	

HOT! Model: S923MAX (Face ID + Camera)	DETAILS
	<p>Material: Zinc alloy + tempered glass</p> <p>Unlock: Face recognition & wifi app(USmart GO) & Palmprint & password & fingerprint & card & key</p> <p>Door thickness: 40-120mm</p> <p>using for wooden door metal door, composite door</p> <p>Weight: 8kg/pcs</p> <p>9000mAh Lithium-ion rechargeable battery</p>
Grey/Red bronze	

Model: S923 (Automatic)	DETAILS
	<p>Material: Zinc alloy + tempered glass</p> <p>Unlock: wifi app(USmart GO) & password & Finger Vein & card & key</p> <p>Door thickness: 40-120mm</p> <p>using for wooden door metal door, composite door</p> <p>Weight: 8kg/pcs</p> <p>5000mAh Lithium-ion rechargeable battery</p>
Grey/Red bronze	

HOT! Model: S889MAX	DETAILS
	<p>Material: Aluminum alloy + Acrylic</p> <p>Unlock: password & fingerprint & wifi app(USmart GO) & card & key</p> <p>Door thickness: 38-120mm</p> <p>using for wooden door metal door, composite door</p> <p>Panel size: 413*80mm</p> <p>Weight: 6kg/pcs</p> <p>4200mAh Lithium-ion rechargeable battery</p>
Dark grey / coffe gold	

HOT! Mode: S925 MAX	DETAILS
	Materail: Aluminum alloy + Acrylic Unlock: Tuya APP & password & fingerprpint & card & key Door thickness: 40-120mm using for wooden door metal door Weight: 6.5 kg/pcs 3200mAh Lithium-ion rechargeable batteris
Black	

HOT! Mode: S929MAX	DETAILS
	Materail: Aluminum alloy Unlock: Tuya APP & password & fingerprpint & card & key Door thickness: 40-120mm using for wooden door metal door Weight: 6.5 kg/pcs 3200mAh Lithium-ion rechargeable batteris
Dark Grey	

HOT! Model: S932MAX	DETAILS
	Materail: Aluminum alloy Unlock: Tuya APP & password & fingerprpint & card & key Door thickness: 40-120mm using for wooden door metal door Weight: 6.5 kg/pcs 3200mAh Lithium-ion rechargeable batteris
Black	

HOT! Model: S933MAX	DETAILS
	Materail: Aluminum alloy Unlock: TTlock APP & password & fingerprpint & card & key Door thickness: 40-120mm using for wooden door metal door Weight: 6.5 kg/pcs 3200mAh Lithium-ion rechargeable batteris
Black	

Model: S915MAX	DETAILS
	Materail: Zinc alloy + Acrylic Unlock: Wifi app(USmart GO) & password & fingerprint & card & key Door thickness: 40-120mm Size: 410*85mm using for wooden door metal door, composite door Weight: 8kg/pcs 7.4V Lithium-ion rechargeable battery
Black/Gold/Grey	

Model: S918 S918max	DETAILS
	Materail: Aluminum alloy + Acrylic Unlock: Tuya app(S918)/Usmart go(S918max) & password & fingerprint & card & key Door thickness: 40-110mm Size: 394*78mm using for wooden door metal door, composite door Weight: 6kg/pcs 7.4V 3200mAh Lithium-ion rechargeable battery
S918: Coffe/Dark grey S918MAX: Coffe/Dark grey	

Model: S920MAX(face+camera)	DETAILS
	<p>Material: Aluminum alloy + Acrylic</p> <p>Unlock (S920-3) : Face ID & Tuya app & password & fingerprint & card & key</p> <p>Door thickness: 40-100mm using for wooden door, metal door, composite door</p> <p>Weight: 6.5kg/pcs</p> <p>7.4V 4200mAh Lithium-ion rechargeable battery</p>
Grey PCS	

HOT! Model: S812	DETAILS
	<p>Material: Aluminum alloy+stainless</p> <p>Unlock: TTlock/Tuya APP & Password & fingerprint & card & key & USB port</p> <p>Door thickness: 30-60mm using for using for wooden door metal door, composite door</p> <p>Panel size: 170*60mm</p> <p>Weight: 2kg/pcs</p> <p>Power: 4 AA Alkaline Battery</p>
Black	

HOT! Model: S812-2	DETAILS
	<p>Material: Aluminum alloy +stainless</p> <p>Unlock: TT lock /Tuya app & Password & fingerprint & card & key & USB port</p> <p>Door thickness: 30-90mm using for using for wooden door metal door Panel size: 170*60mm</p> <p>Weight: 2kg/pcs</p> <p>Power: 4 AA Alkaline Battery</p> <p>Waterproof extra 3 USD</p> <p>Double side fingerprints extra 10 USD</p>
Black	

Model:S812-3 Waterproof with 2 side fingerprint	DETAILS
	Materail: Aluminum alloy +stainless Unlock: tuya app &Password & fingerprint & card & key & USB port Door thickness: 30-90mm using for using for wooden door metal door Weight: 2.5kg/pcs Power: 4 AA Alkaline Battery
Black	Cut 10usd for only 1 side fingerprint One side can tuya or ttlock

Model: S603	DETAILS
	Materail: Zinc alloy Unlock: BLE DADA IOCK APP & Password & fingerprint & card & key Door thickness: 35-55mm Weight: 1.5kg/pcs using for wooden door metal door, composite door Power: 4 AAA Alkaline Battery
Black	

Model: S501	DETAILS
	Materail: Aluminum alloy +stainless Unlock: fingerprint Fingerprint capacity: 10 pcs GW: 110g NW: 97g Box sizes: 10.5*7.5*1.8cm Carton sizes: 40*40*13cm 13KG/carton, 100pcs Weight: 0.5kg/pcs Power: 150 mah IP56
Silver/Black	

Model: S502	DETAILS
	<p>Materail: Aluminum alloy +stainless Unlock: Tuya BLE APP& fingerprint Fingerprint capacity: 10 pcs Weight: 0.5kg/pcs Power: 200 mah IP65</p>
<p>Black</p>	

Model: S604	DETAILS
	<p>Materail: Zinc alloy Unlock: Tuya App & Password & fingerprint & key Door thickness: 35-55mm Weight: 1.5kg/pcs using for wooden door metal door, composite door Power: 800mAh rechargeable battery</p>
<p>black/silver/grey/gold</p>	

Model: S605	DETAILS
	<p>Materail: Aluminum alloy Unlock: Tuya App& Password & fingerprint & key Door thickness: 35-55mm Weight: 1.5kg/pcs using for wooden door metal door, composite door Power: 800mAh rechargeable battery</p>
<p>Black/Sliver/Golden/Red bronze</p>	

Model: S606	DETAILS
	<p> Materail: Zinc alloy Unlock: fingerprint & key Door thickness: 35-55mm Weight: 1.5kg/pcs using for wooden door metal door, composite door Power: 800mAh rechargeable battery </p>
Black/ Champagne gold	

HOT! Model: S919-5	DETAILS
	<p> Materail: Aluminum alloy Unlock: TT lock /Tuya app & Password & fingerprint & card & key & USB port Door thickness: 35-50mm Weight: 1.5kg/pcs using for using for wooden door metal door, composite door Power: 4 AA Alkaline Battery </p>
Black/ Silver	

Model: G8S	DETAILS
	<p> Materail: Aluminum alloy Unlock: Bluetooth app (DaDalock) & Password & fingerprint & card & Key&USB port Using for Glass door Weight: 3kg/pcs Power: 4 AA Alkaline Battery </p>
G8S (Black)	

Model: G1S G3S G6S	DETAILS
	<p>Material: High-strength Aluminum alloy Unlock: Bluetooth app (TTlock) & Password & fingerprint & card & USB port G3S support Tuya BLE APP Using for Glass door Weight: 3kg/pcs Power: 4 AA Alkaline Battery</p>
<p>G1S: G3S: (Black/silver) G6S: (Black)</p>	

Model: G2S G5S (3DFace recognition)	DETAILS
	<p>Material: High-strength Aluminum alloy Unlock: G2S:Tuya app & Password & fingerprint & card & USB port G5S:3D Face recognition&Tuya app&Palmprint& Password & fingerprint & card & USB port Using for Glass door Weight: 3kg/pcs Power: 4 AA Alkaline Battery (G5S with Lithium-ion rechargeable battery)</p>
<p>G2S: G5S: (Black/silver) (Black)</p>	

Model: S612 Waterproof IP65	DETAILS
	<p>Material: Zinc alloy Unlock: Bluetooth app (TTlock)&Password & fingerprint & IC card & key &USB port Door thickness: 30-60mm using for wooden door metal door, composite door Panel size: 400*42mm Weight: 5.5kg/pcs Power: 4 AA Alkaline Battery</p>
<p>Black/ Red bronze: (Double side fingerprint) (Single side fingerprint)</p>	

Model: S615 Waterproof IP68	DETAILS
	<p> Material: Aluminum alloy Unlock: Bluetooth app (TTlock)&Password & fingerprint & IC card & key &USB port Door thickness: 30-60mm using for wooden door metal door, composite door Panel size: 220*45mm Weight: 4 kg/pcs Power: 4 AA Alkaline Battery </p>
<p> Black (Double side fingerprint) </p>	

Model: S816	DETAILS
	<p> Material: Stainless Unlock: Bluetooth app (TTlock) & Password & card & key & USB port Door thickness: 38-50mm using for wooden door Weight: 3kg/pcs Power: 4 AA Alkaline Battery </p>
<p>Silver/Black/rose gold</p>	



Smart Lock stands

Model: A	DETAILS
	<p> Materail: Wooden Weight: 3kg/pcs Using for 6068*24*240mm lock body </p>
<p style="text-align: center;">Gold</p>	

Model: B	DETAILS
	<p> Materail: Aluminum alloy Weight: 2kg/pcs Using for 5050*160*22mm lock body </p>
<p style="text-align: center;">Grey</p>	

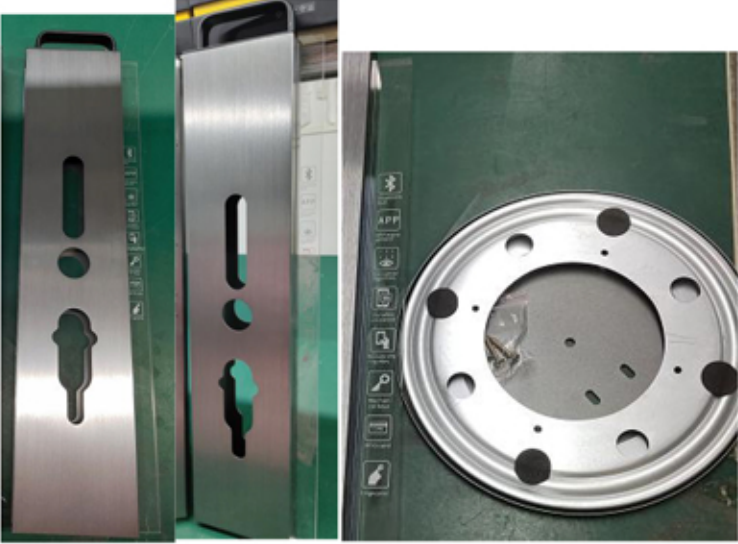
Model: C	DETAILS
	<p> Materail: Aluminum alloy Weight: 3kg/pcs Using for 6068*24*240mm lock body </p>

Model: D	DETAILS
	<p> Materail: Wooden Weight: 2kg/pcs Using for 5050*160*22mm lock body </p>
<p style="text-align: center;">White</p>	

Model: E	DETAILS
 <p>帆船款 24x240mm 【LED发光】</p>	<p>Material: Acrylic Weight: 3kg/pcs Using for 6068*24*240mm lock body</p>

Smart Lock Mortises

Mortises: 5050	DETAILS
	<p>Material: Stainless Weight: 0.6kg/pcs Size: 22*160mm</p>



Mortises: 3585	DETAILS
	<p>Materail: Stainless</p> <p>Weight: 0.6kg/pcs</p> <p>Size: 22*240mm</p>
<p>(with hooks)</p>	

Mortises: 4085	DETAILS
	<p>Materail: Stainless</p> <p>Weight: 0.6kg/pcs</p> <p>Size: 22*240mm</p>
<p>(with hooks)</p>	

Mortises: 4585	DETAILS
	<p>Materail: Stainless</p> <p>Weight: 0.6kg/pcs</p> <p>Size: 22*240mm</p>
<p>(with hooks)</p>	



Mortises: 6085	DETAILS
	<p>Material: Stainless</p> <p>Weight: 0.8kg/pcs</p> <p>Size: 22*240mm</p>
(with hooks)	

Mortises: 5572	DETAILS
	<p>Material: Stainless</p> <p>Weight: 0.8kg/pcs</p> <p>Size: 22*240mm</p>

Mortises: 6068	DETAILS
	<p>Material: Stainless</p> <p>Weight: 1.2kg/pcs</p> <p>Size: 22*240mm</p>

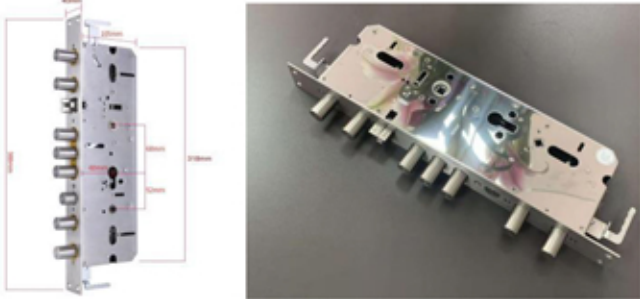

Mortises: 6068	DETAILS
	<p>Materail: Stainless</p> <p>Weight: 1.2kg/pcs</p> <p>Size: 30*240mm</p>

Mortises: 6068	DETAILS
	<p>Materail: Stainless</p> <p>Weight: 2kg/pcs</p> <p>Size: 30*388mm</p>